

Managing Reproduction In High Producing Dairy Herds



Paulo David Carvalho, PhD
Paulo.carvalho@stgen.com



Euroopa Maaelu Arengu
Põllumajandusfond:
Euroopa investeringud
maapiirkondadesse

How to get cows pregnant?

Rule 1: Put semen in the cow.



Rule 2: If she is not pregnant....
refer to rule one

How to achieve high 21d pregnancy rate

Aggressively inseminate cows at the end of the voluntary waiting period

Increase fertility to first AI

Identify nonpregnant cows and aggressively reinseminate them

Increase fertility to 2nd and greater AI

21-Day Pregnancy Rate

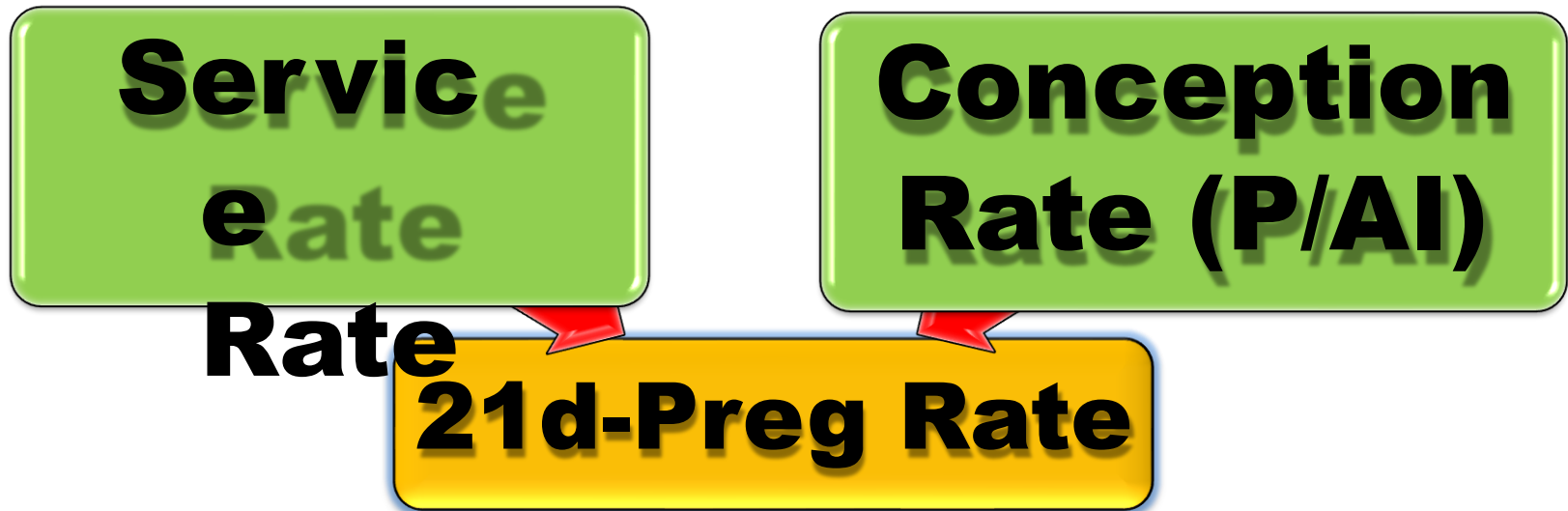

What to Expect Then?... \$/cow/year

Current 21-d PR (%)

10	11	12	13	14	15	16	17	18	19	20	21	22	23	24	25	26	27	28	29
----	----	----	----	----	----	----	----	----	----	----	----	----	----	----	----	----	----	----	----

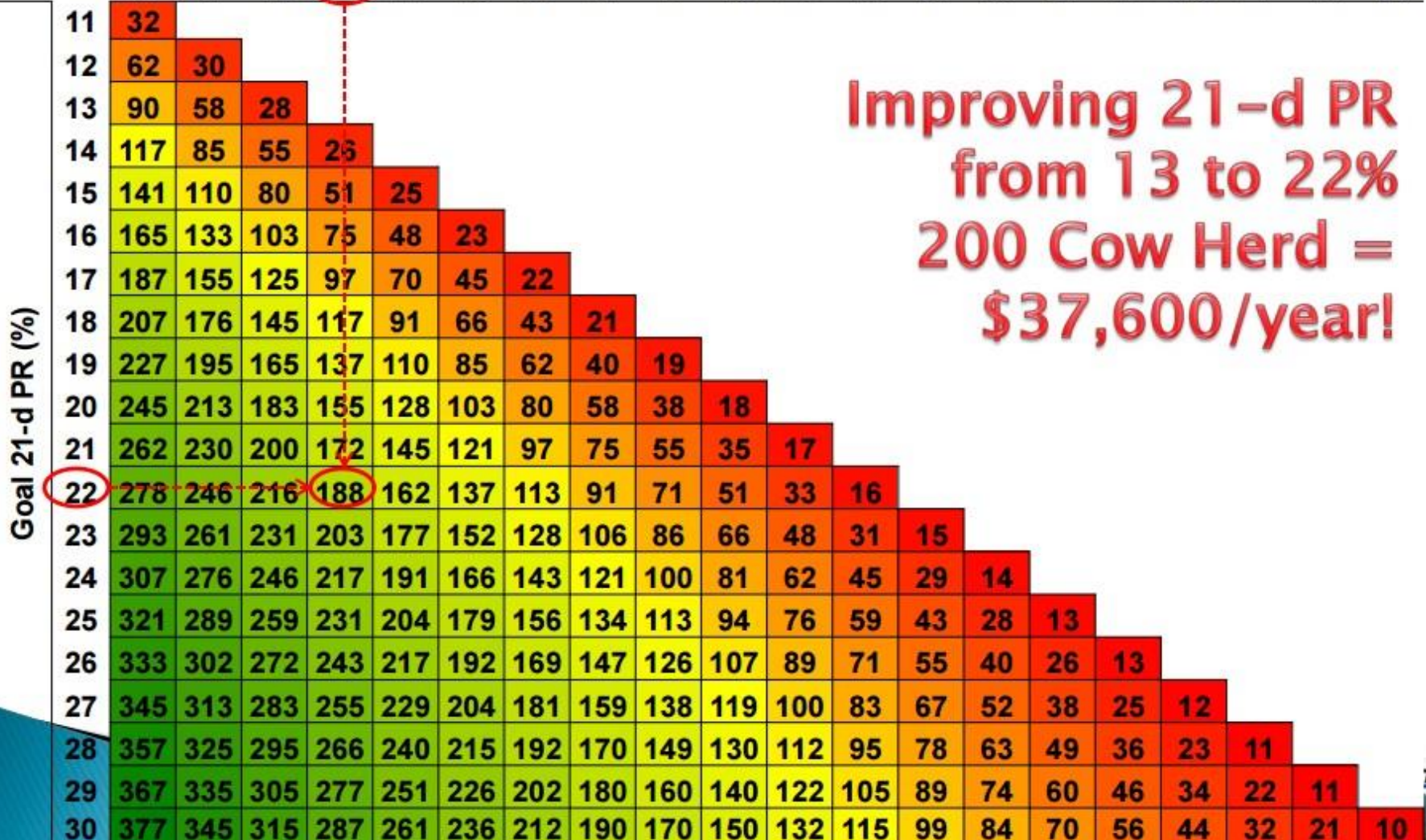

Improving 21-d PR
from 13 to 22%
200 Cow Herd =
\$37,600/year!

Current Preg Rate Distribution - 2019

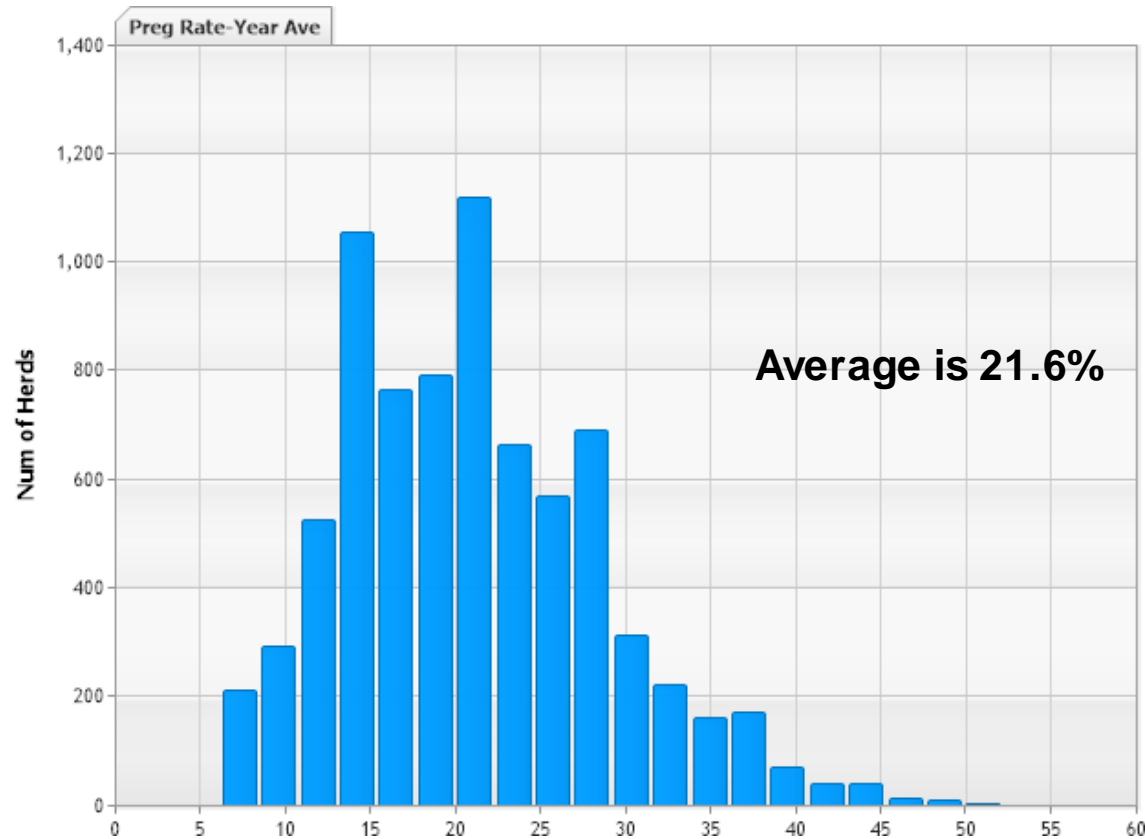

Dataset: DRMS, USA, Holstein, 50 cows or more, Preg Rate=5-50%. Dataset is 7051 herds, 1,798,000 cows with DRMS.
(this excludes herds that use bulls and/or only enter a breeding when pregnant but not all breedings)

Distribution of DIM at 1st AI

GRAPH BRED1 BY FDAT FOR FDAT > 1/15/00

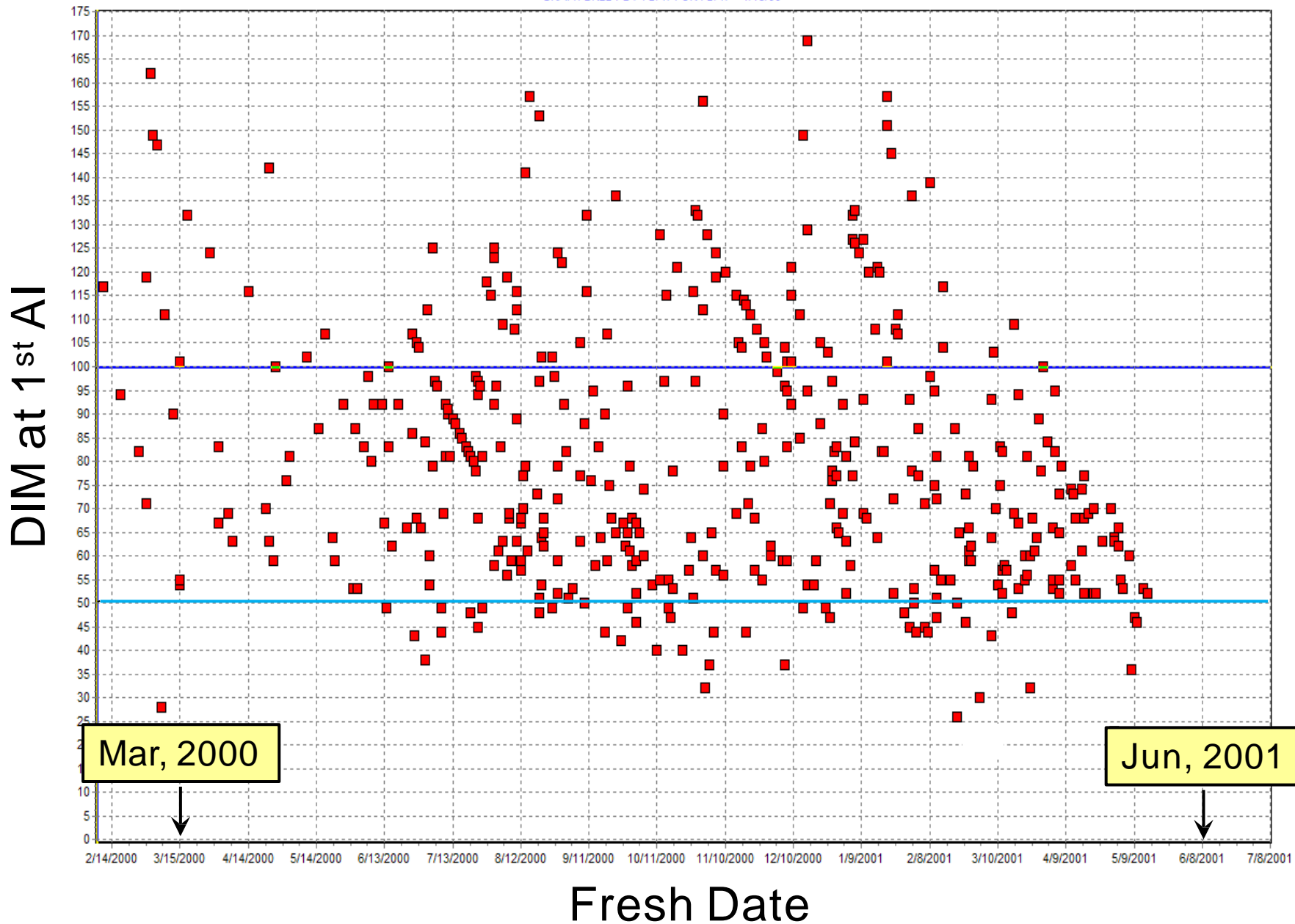

Ovsynch

Pursley, Mee, & Wiltbank, 1995
Theriogenology 44:915

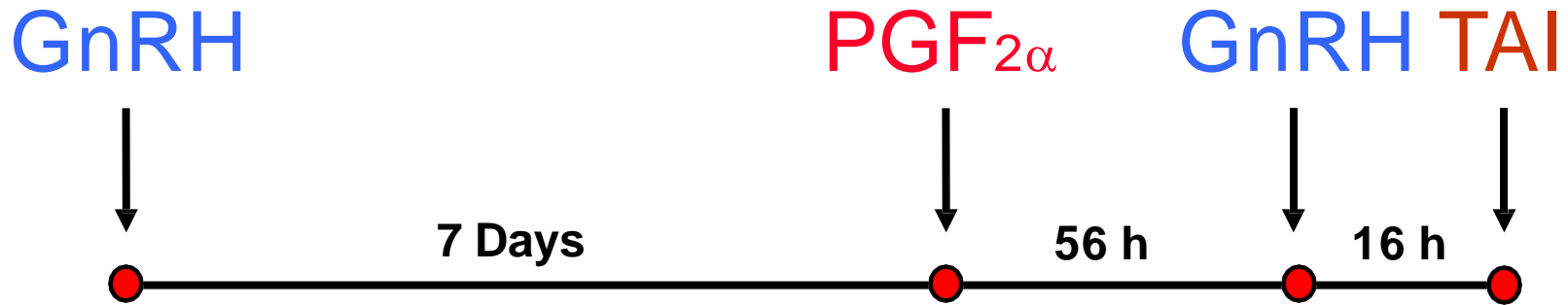

Reproductive Management of Lactating Dairy Cows Using Synchronization of Ovulation

1997 J Dairy Sci 80:301-306

J. R. PURSLEY, MICHAEL R. KOSOROK,¹ and MILO C. WILTBANK²

Department of Dairy Science, University of Wisconsin, Madison 53706

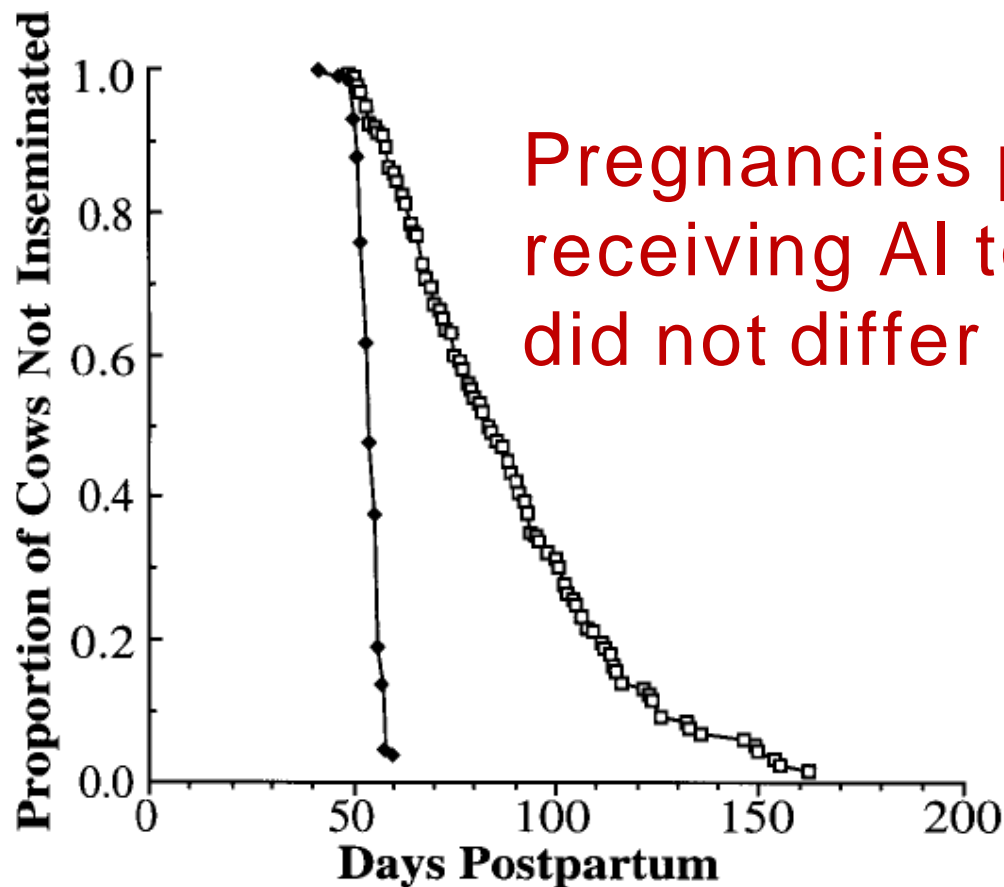

Pregnancies per AI between cows receiving AI to estrus vs. Timed AI did not differ (39% vs. 37%)

Figure 1. Survival curves for days to first AI in lactating Holstein cows managed with standard reproductive strategies (□) versus timed AI after synchronization of ovulation (◆).

“Back Door” Ovsynch

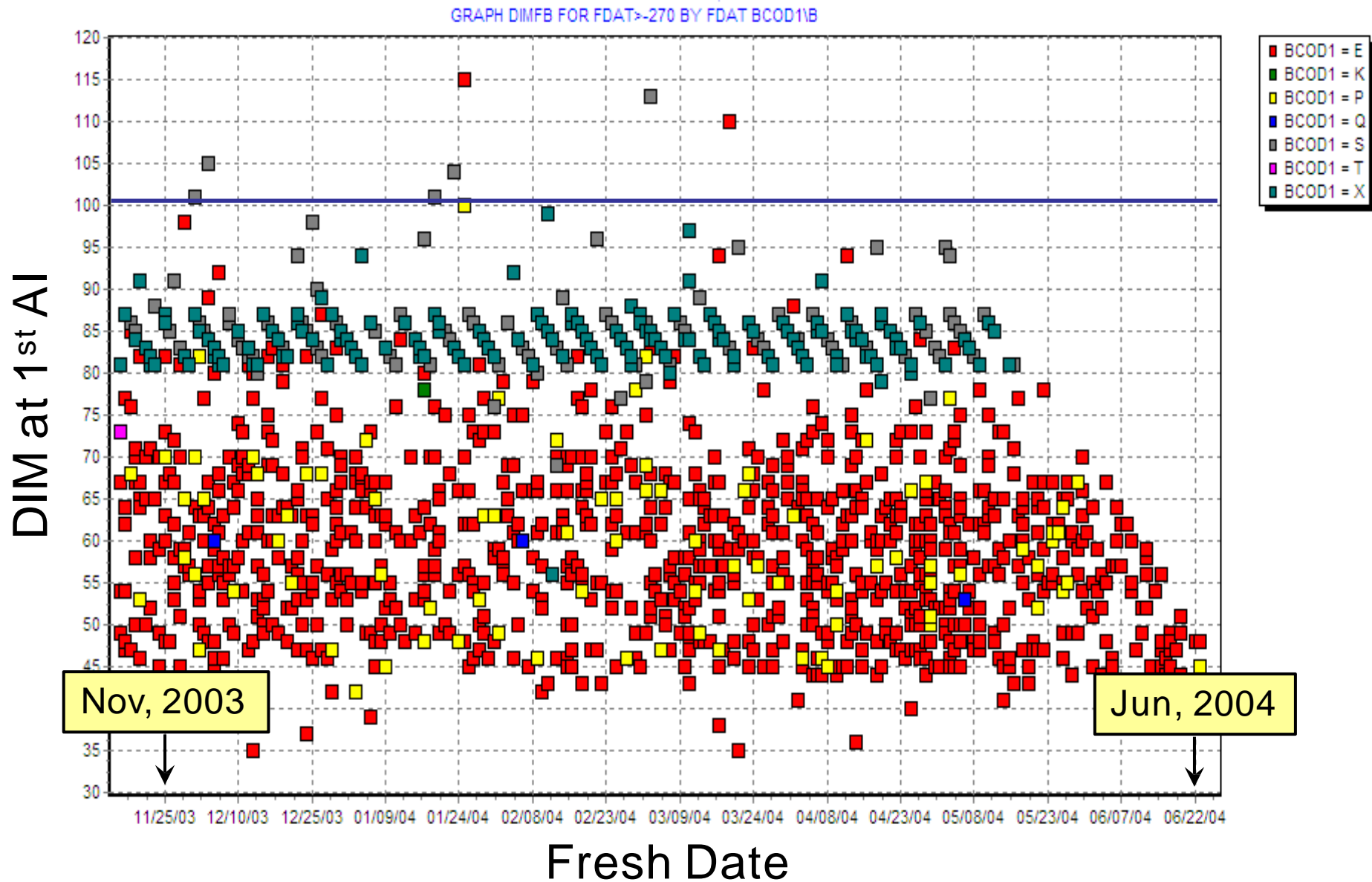

Effects of Presynchronization and Bovine Somatotropin on Pregnancy Rates to a Timed Artificial Insemination Protocol in Lactating Dairy Cows

F. Moreira,* C. Orlandi,* C. A. Risco,† R. Mattos,*

F. Lopes,* and W. W. Thatcher*

*Department of Dairy and Poultry Sciences,
University of Florida, Gainesville, 32611

†Large Animal Clinical Sciences,
University of Florida, Gainesville, 32610

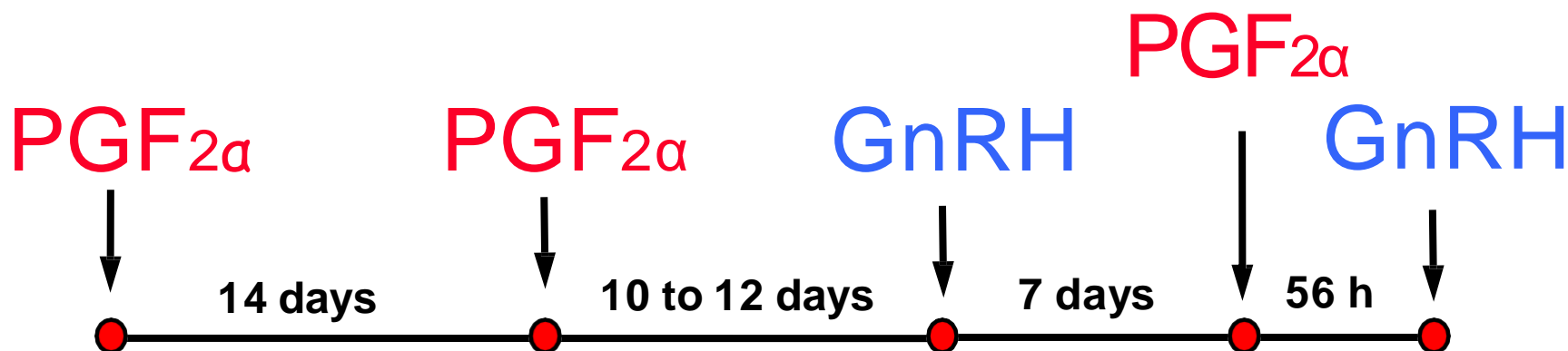



Presynch-Ovsynch 14/11

Galvao et al., 2007; J. Dairy Sci. 90:4212–4218

Sun	Mon	Tue	Wed	Thu	Fri	Sat
				← PGF →		
				← PGF →		
	GnRH					
	PGF		GnRH	TAI		

Presynch-Ovsynch + Detection of Estrus

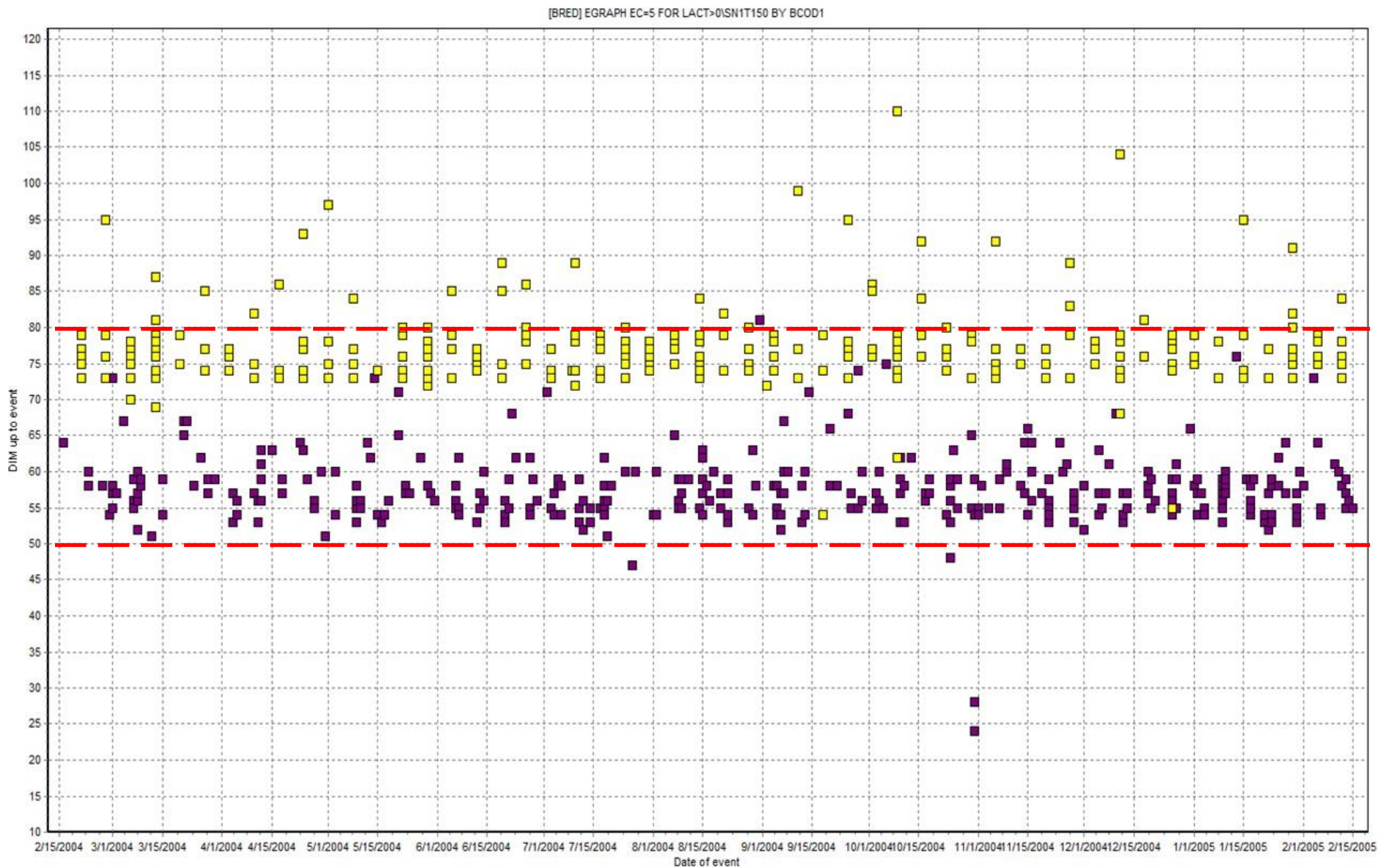

Presynch/Ovsynch Limitations

- 1) Anovular cows are not affected
23% of the cows are not cycling
- 2) Cows are not tightly presynchronized
50% in heat 3 to 4 days the PGF

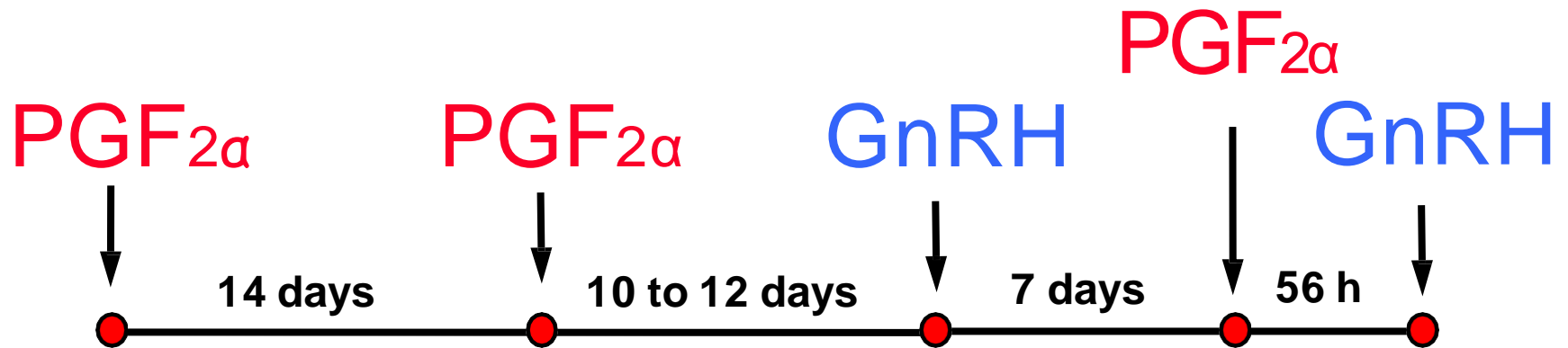

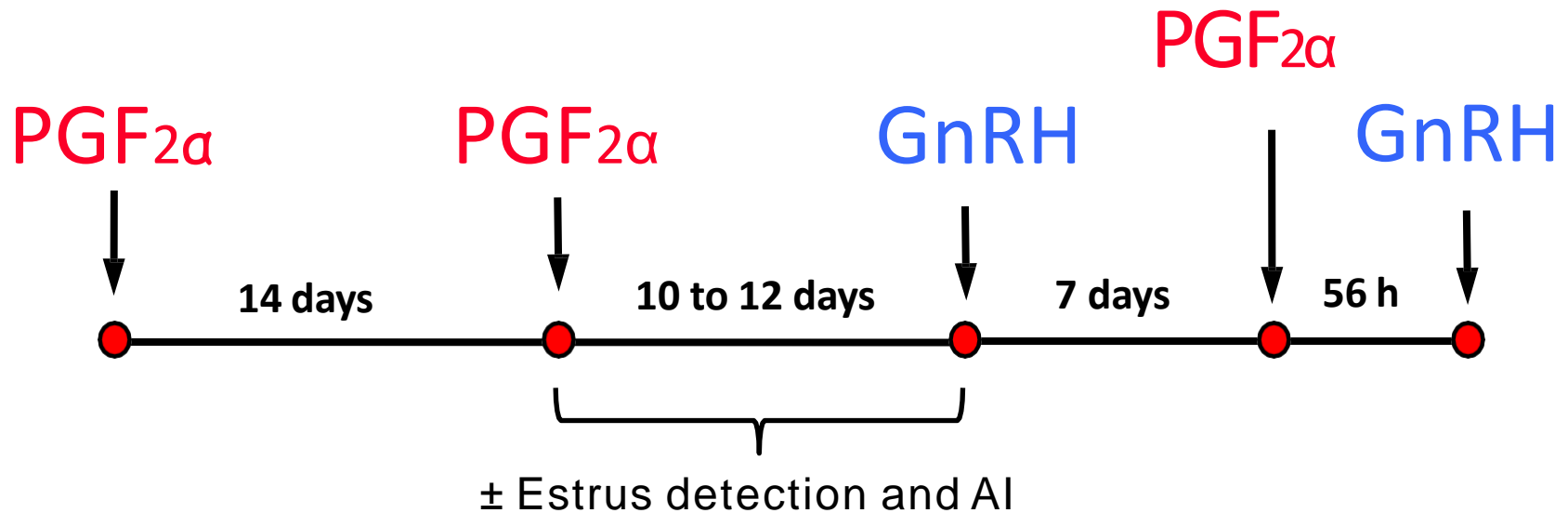

Pregnancies per AI were greater when 100% cows were inseminated in TAI after completion of the Presynch-Ovsynch protocol (42% vs. 33%)



Double Ovsynch

Souza et al., 2008; Theriogenology 70:208-215

Sun	Mon	Tue	Wed	Thu	Fri	Sat
					GnRH	
					PGF	
	GnRH					
	GnRH					
	PGF		GnRH	TAI		

Double-Ovsynch for first timed AI

[BRED] EGRAPH EC=5 FOR LACT>0|SN1|T150 BY LGRP

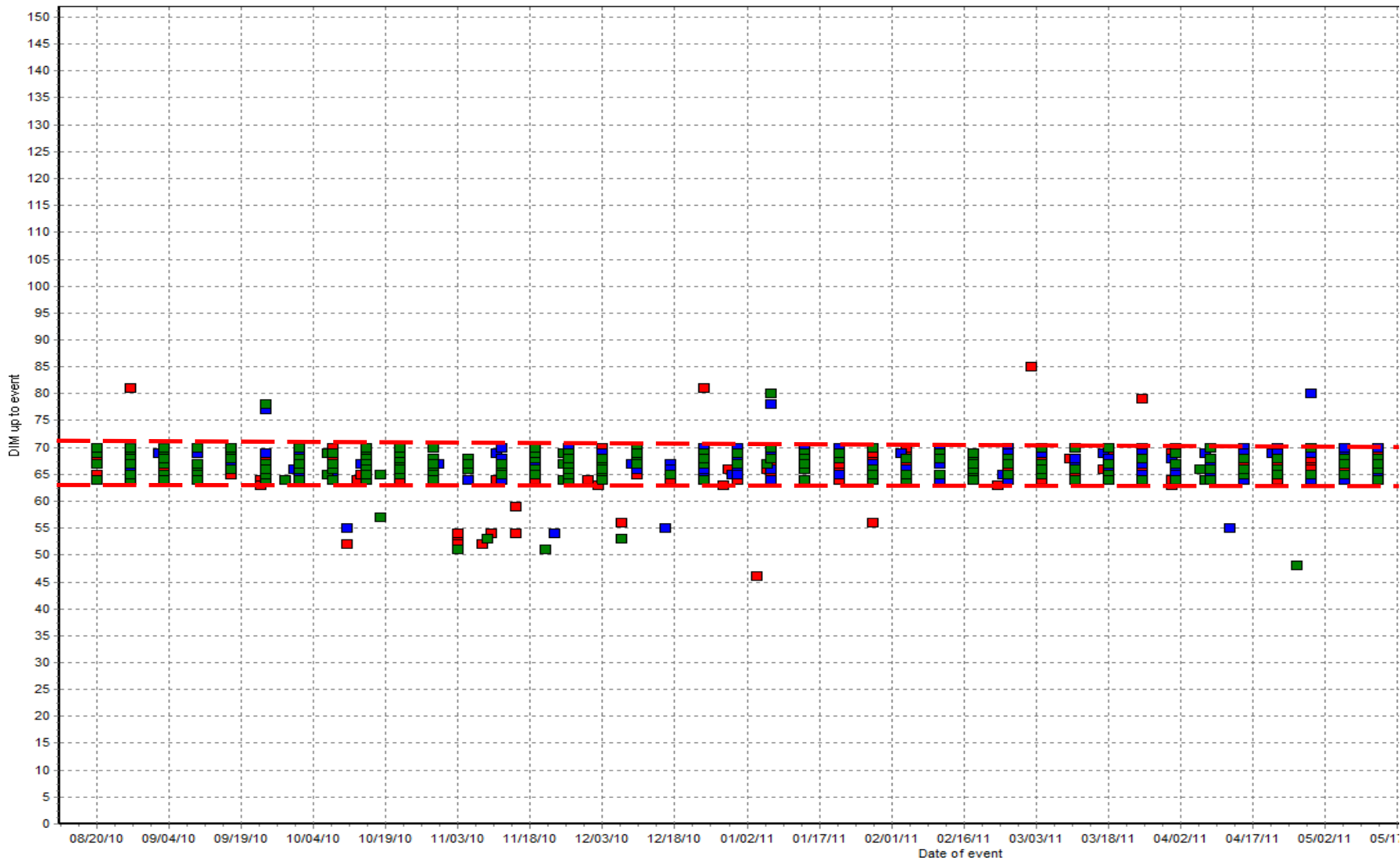



J. Dairy Sci. 95:7003–7014

<http://dx.doi.org/10.3168/jds.2011-5260>

© American Dairy Science Association[®], 2012.

Presynchronization with Double-Ovsynch improves fertility at first postpartum artificial insemination in lactating dairy cows

□ Presynch-Ovsynch ■ Double-Ovsynch

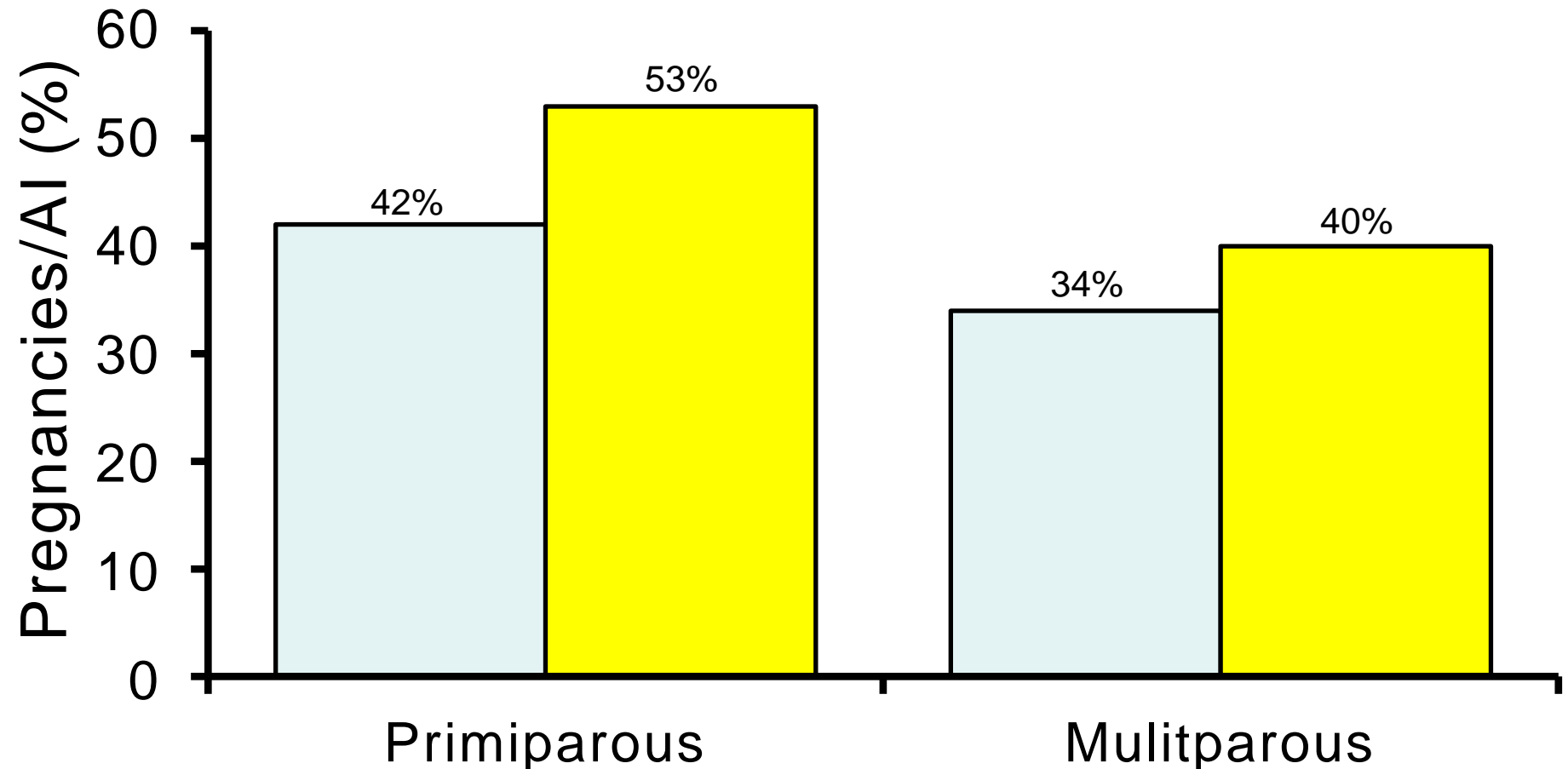

Return to Estrus after AI

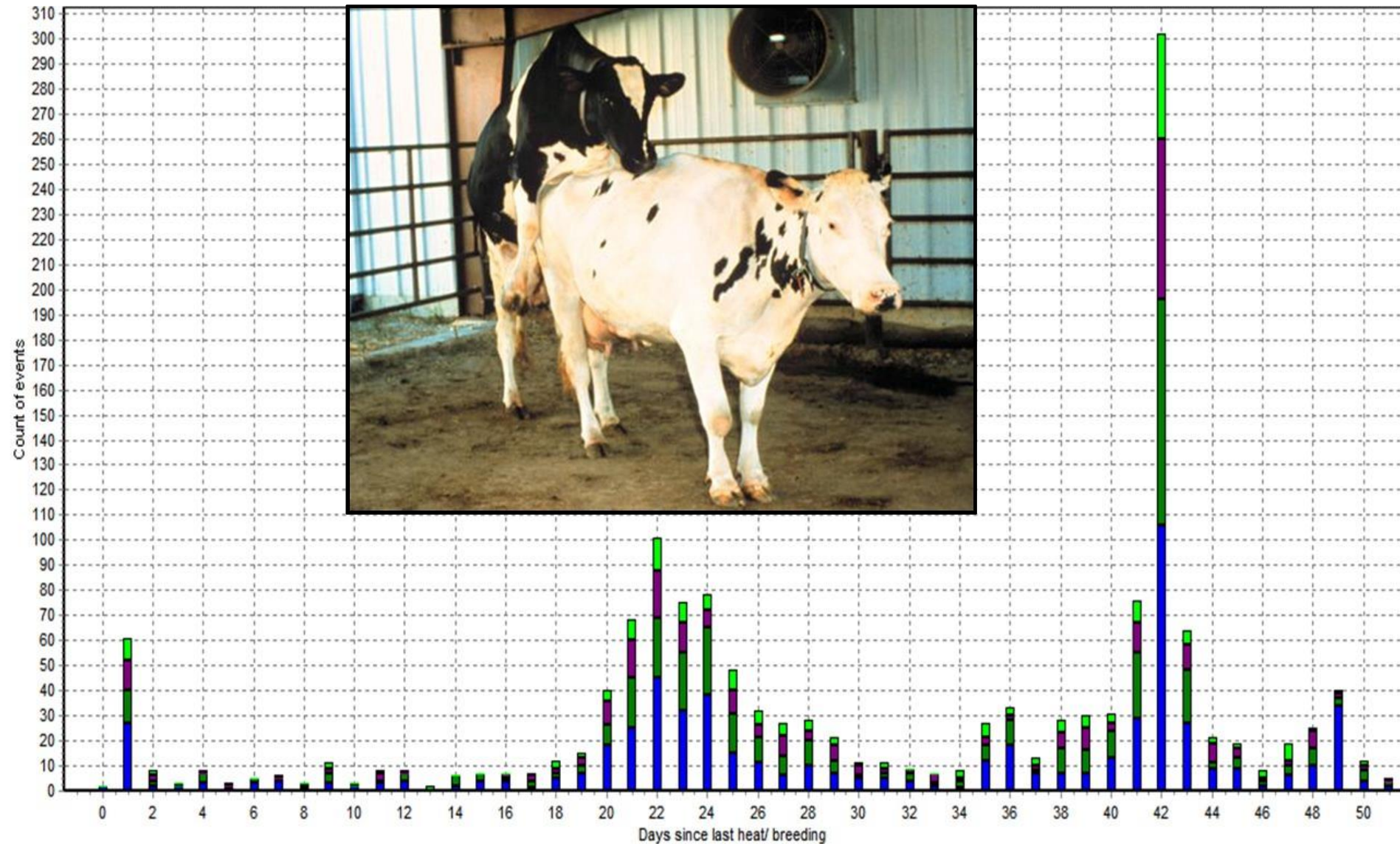

Effect of timing of initiation of a resynchronization protocol on fertility of lactating dairy cows

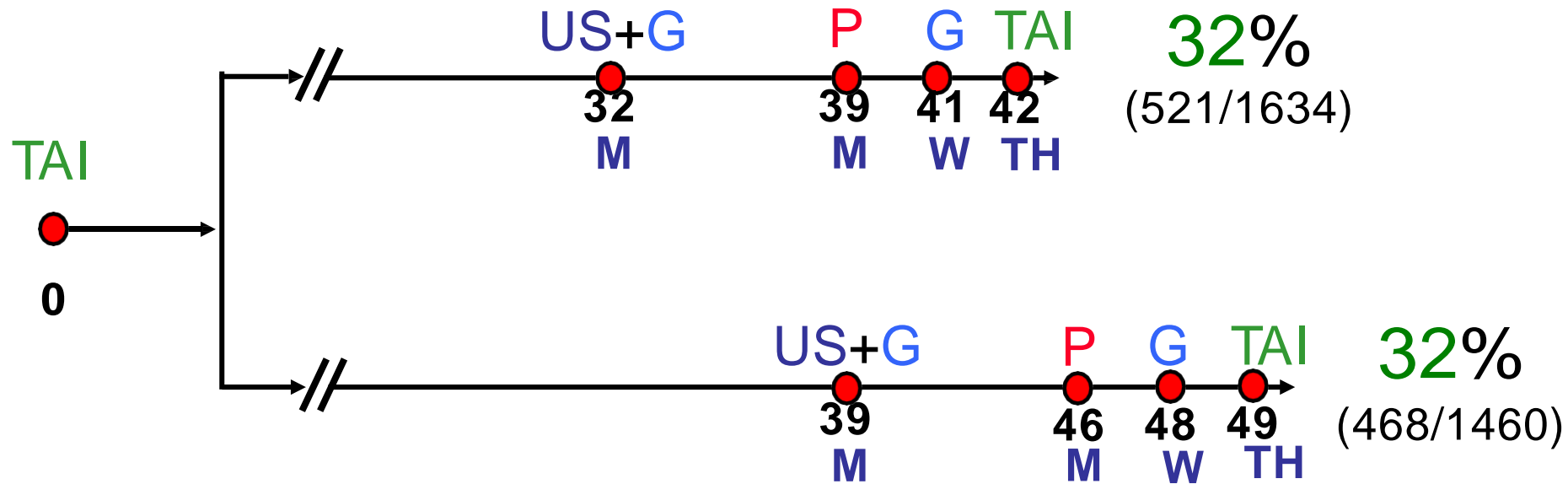

Bilby et al., JDS 3013
Lopes et al., JDS 2013

Synch and Resynch

First TAI

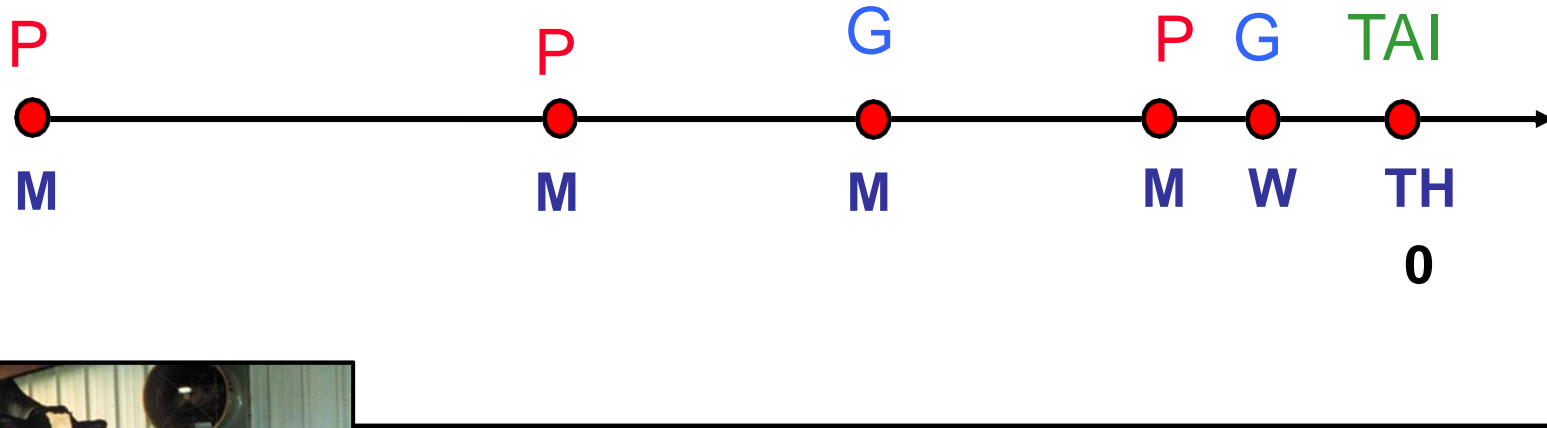

Resynch for nonpregnant cows

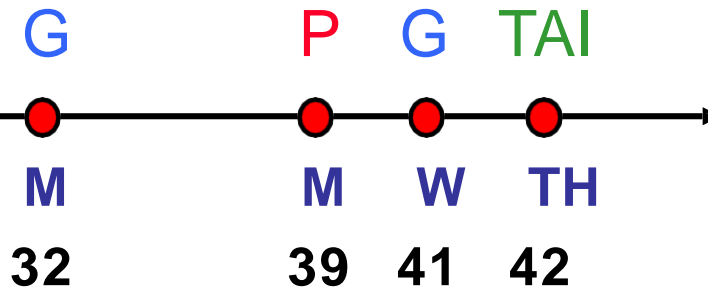



Adding a second prostaglandin $F_{2\alpha}$ treatment to but not reducing the duration of a PRID-Synch protocol increases fertility after resynchronization of ovulation in lactating Holstein cows

V. G. Santos,^{*1} P. D. Carvalho,^{*1} C. Maia,[†] B. Carneiro,[†] A. Valenza,[‡] P. M. Crump,^{*} and P. M. Fricke^{*2}

^{*}Department of Dairy Science, University of Wisconsin, Madison 53706

[†]Diessen Serviços Veterinários Lda, 7001 Évora, Portugal

[‡]CEVA Santé Animale, 10 Avenue de la Ballastiere, 33500 Libourne, France

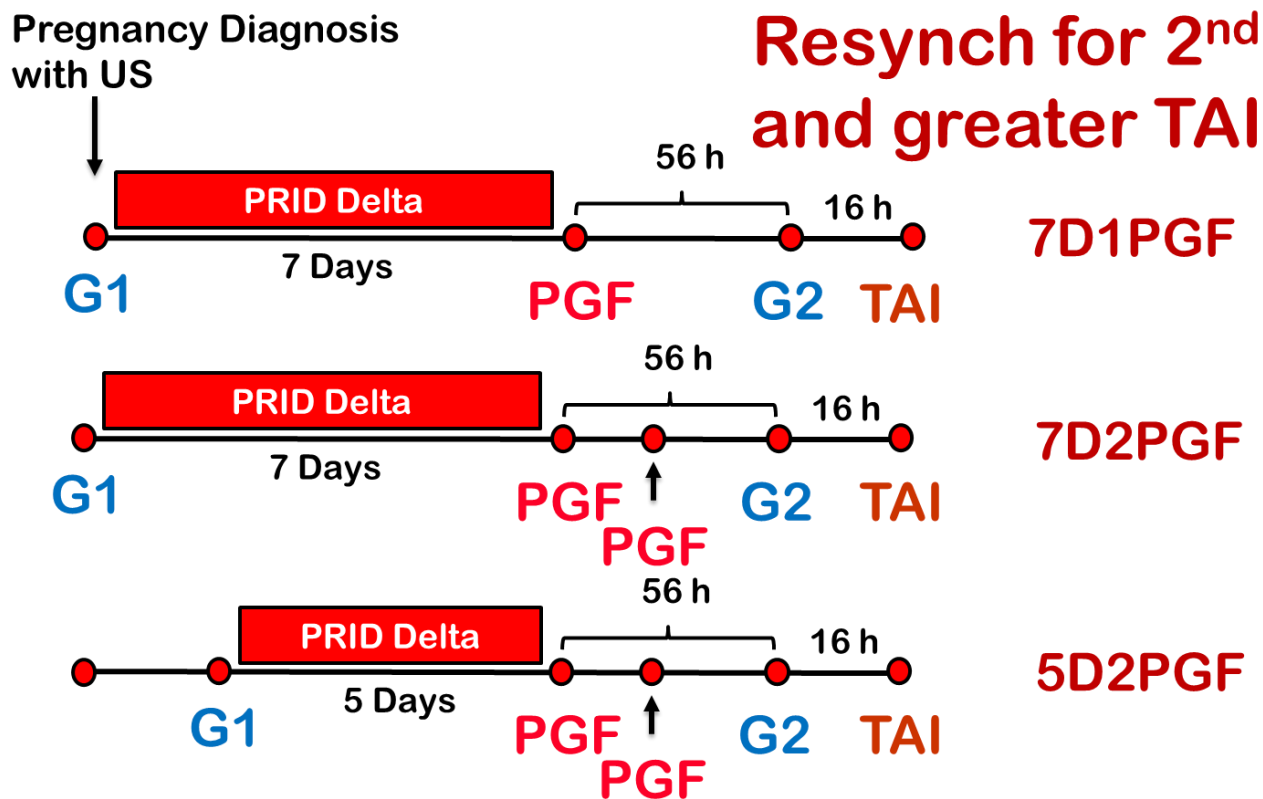

Effect of treatment on P/AI

7D1PGF 7D2PGF 5D2PGF

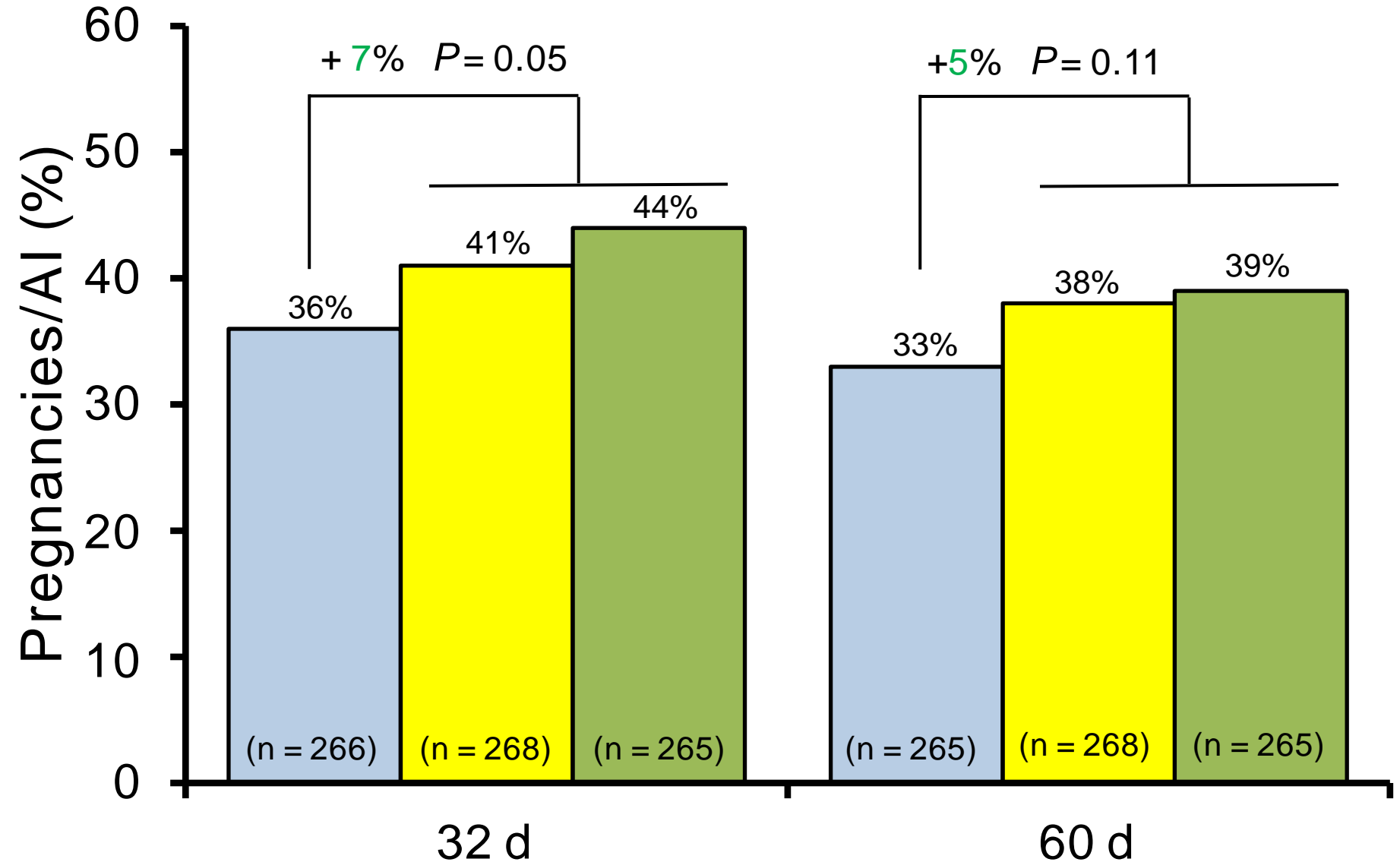

Effect of vaginal discharge at PRID removal on P/AI

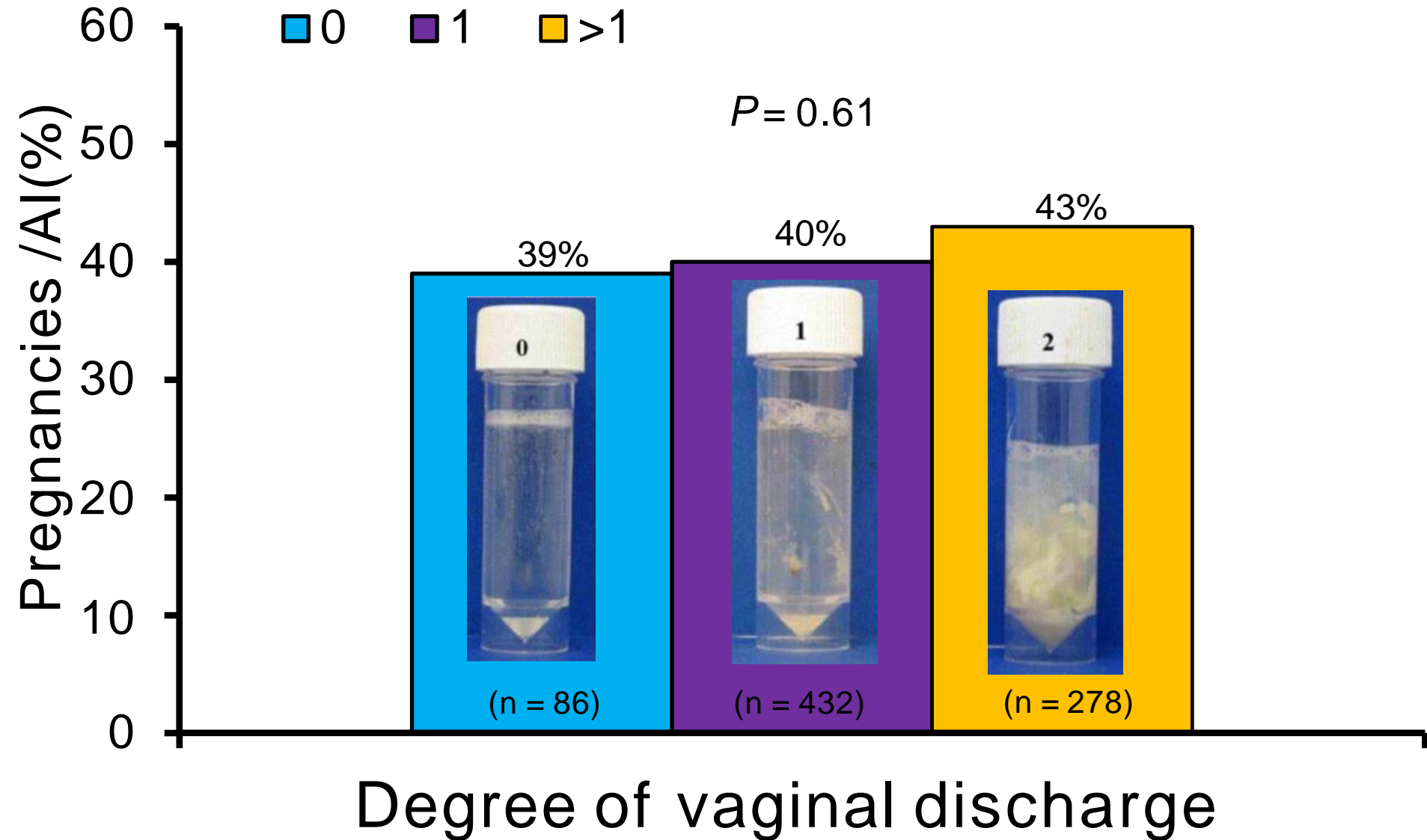

Positive proof of global warming.



**18th
Century**

1900

1950

1970

1980

1990

more awesome pictures at THEMETAPICTURE.COM

Effect milk production on core body temperature

Batista et al., 2015

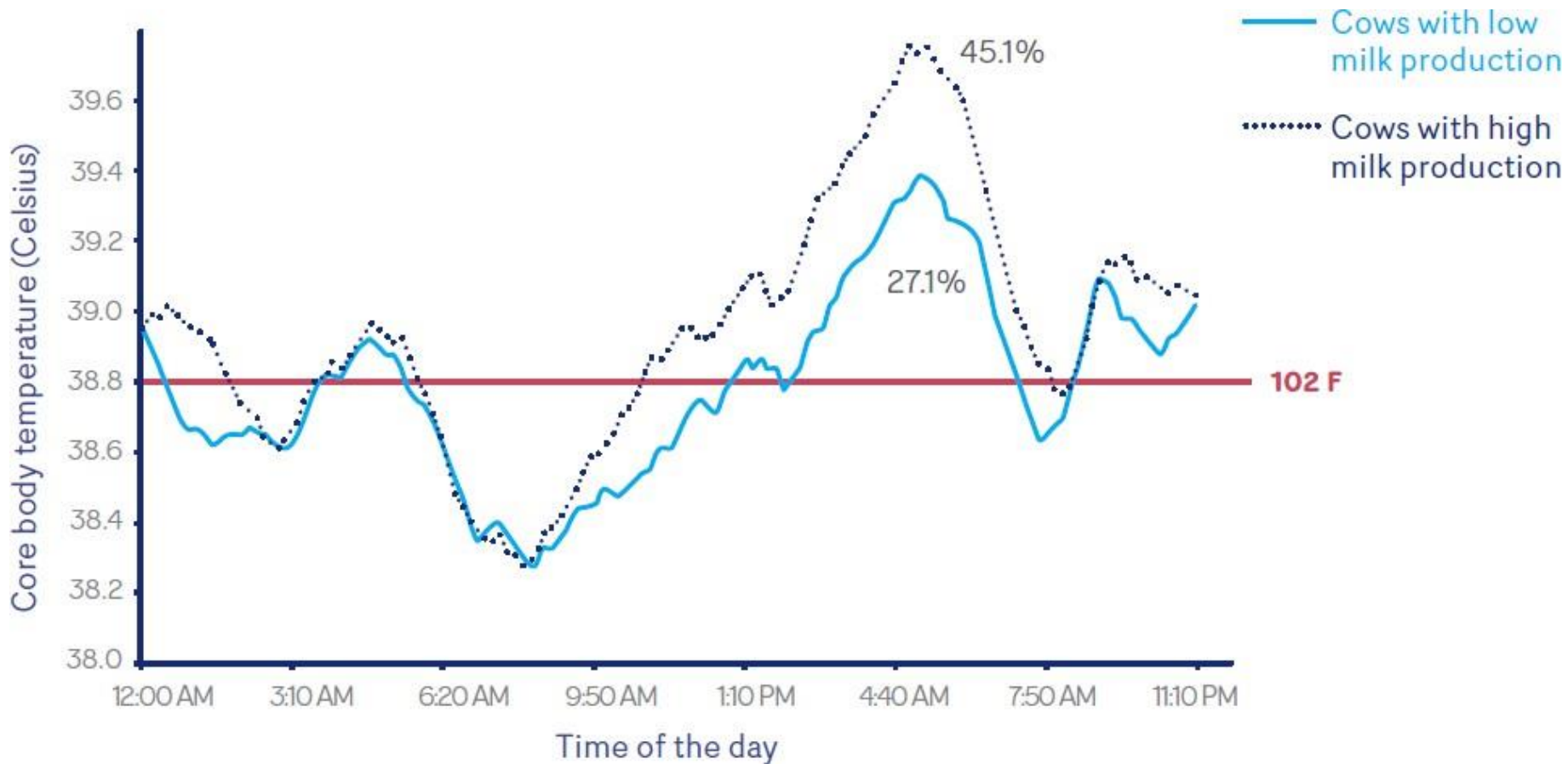





Storage



6 10 2006

Monitor over time

“Whole-Farm Drug Rehab Program”

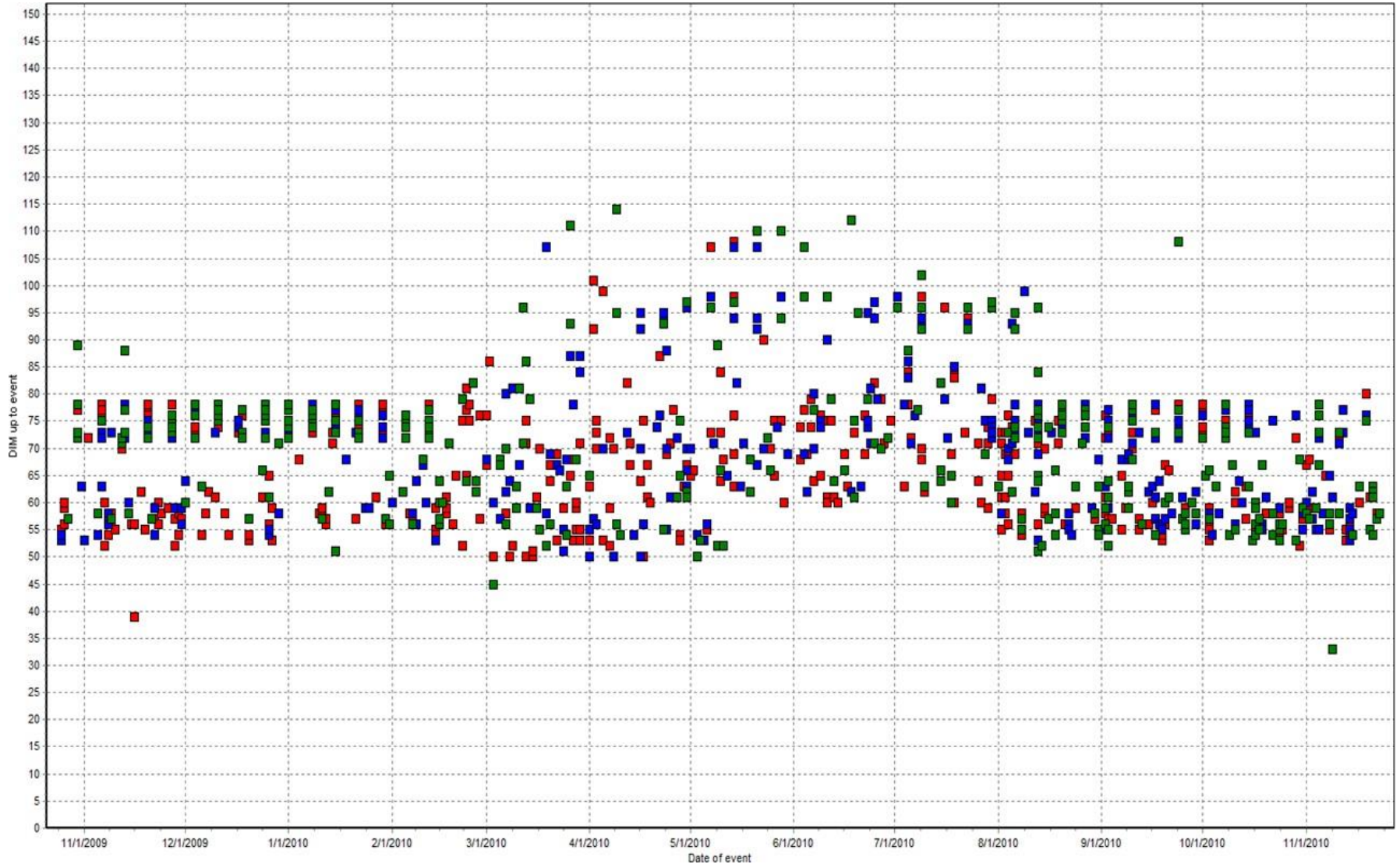

5S principles

Step	Name	Action
1	Sort	Remove unnecessary items from the workplace
2	Straighten	Locate everything at the correct spot
3	Sweep	Clean and eliminate the sources of waste
4	Standardize	Make routines and standard procedures
5	Self-discipline	Don't need to re-check all the time

Why so many nutrition programs have failed to improve child nutrition??



It's the best kind of domino effect.

Experts were pumped when they realized why Bangladeshi kids started growing taller.

www.upworthy.com



In 2014, USAID programs in Bangladesh

- Trained more than 33,000 women farmers to use fertilizer deep placement technology, helping them reduce fertilizer use by as much as 30 percent while increasing crop yields up to 20 percent. WWW.USAID.COM

Red Rock Dairy - Texas



- 2500 milking cows and growing
- 100% TAI
- Double-Ovsynch at ~80 DIM
- Last breeding @ ~250 DIM
- Resynch @ 25 DSLB
- Preg Chek @ 32 DSLB

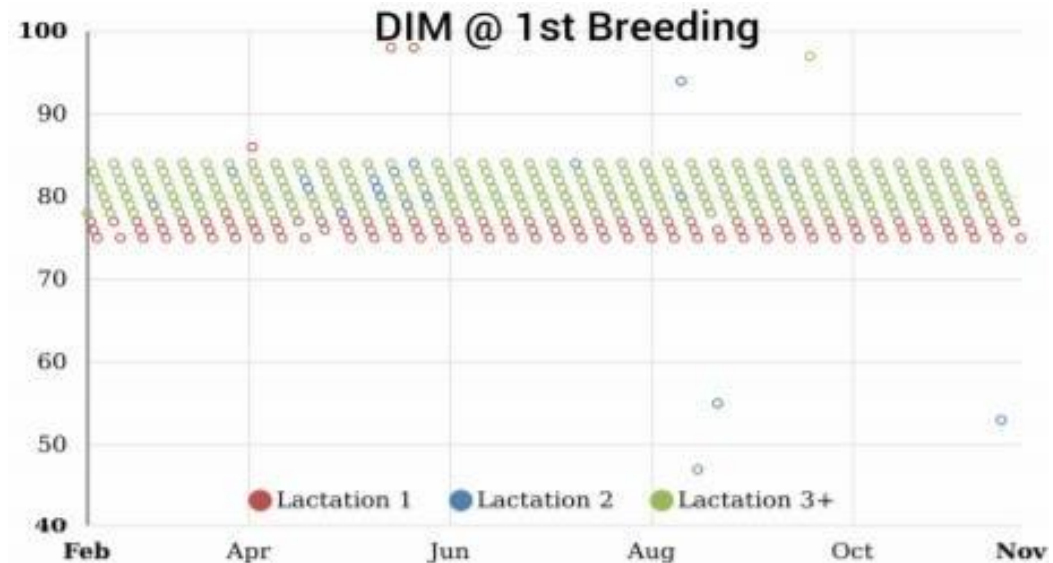

Red Rock Dairy - Texas

TBRD	Lact 0		Lact 1		Lact 2		Lact 3	
1	60% (867)	Sex	49% (635)	Sex	40% (405)	Sex	41% (543)	Beef
2	51% (344)	Sex	45% (337)	Sex	41% (259)	Beef	35% (292)	Beef
3	59% (154)	Sex	42% (196)	Beef	42% (150)	Beef	36% (195)	Beef
4	45% (65)	Beef	35% (164)	Beef	34% (118)	Beef	34% (206)	Beef
Total	57% (1430)	--	45% (1332)	--	40% (932)	--	38% (1236)	--



Service Rate and Preg Rate

Breeding Intensity for						
Date	Bred Elig	Bred	Insem F	Preg	Conc Ra	Preg Ris
2020-02-19	444	324	73	145	45.7	32.7
2020-03-11	420	290	69	113	39.2	26.9
2020-04-01	455	324	71.2	145	44.8	31.9
2020-04-22	462	344	74.5	130	39.2	28.1
2020-05-13	471	326	69.2	137	43.1	29.1
2020-06-03	489	352	72	139	39.9	28.4
2020-06-24	487	328	67.4	129	39	26.5
2020-07-15	491	326	66.4	125	39.6	25.5
2020-08-05	498	362	72.7	127	35.9	25.5
2020-08-26	525	367	69.9	135	37.3	25.7
2020-09-16	589	432	73.3	174	40.9	29.5
2020-10-07	620	449	72.4	191	42.9	30.8
2020-10-28	634	446	70.3	195	43.7	30.8
2020-11-18	598	455	76.1	177	39.1	29.6
2020-12-09	569	386	67.8	186	49.1	32.7
2020-12-30	590	411	69.7	129		
2021-01-20	608	368	60.5	1		
Total	7752	5511	71.1	2248	41.3	29

ThAInks!!

